

## Alloy Versions—Miniature Size

- ▶ Lengths to over 20 feet (6.1 meters)
- ▶ 316 Stainless Steel construction
- ▶ Pressures to 400 PSI (27 bar) – Temperature to 400°F (204°C)

Use these Mini SureSite Indicators where space is tight—they feature a diameter of only 1-1/4"! They can replace existing, antiquated sightglasses for excellent external, visual liquid level indication. Mini SureSite Indicators are ideal for use with clean, low viscosity liquids.

### Typical Applications

- Pharmaceuticals • Medical Equipment • Food and Beverages
- Semiconductor Manufacturing • Boilers

### 1. Mounting Configuration Types

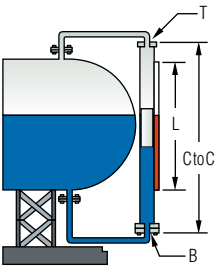
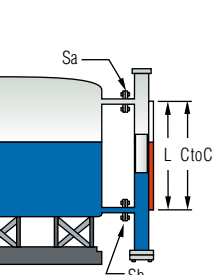
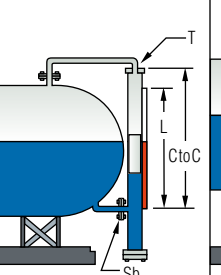
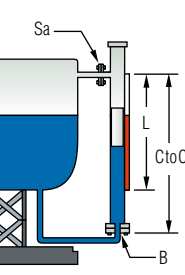
	Type AM	Type BM	Type CM	Type DM
	Top and Bottom Process Connections	Side and Side Process Connections	Top and Side Process Connections	Side and Bottom Process Connections
				
Typical Lengths*	C to C = L + 7.72" (196 mm)	C to C = L	C to C = L + 3" (76 mm)	C to C = L + 5" (127 mm)
Flag Material	Plastic (300°F/148.9°C) or Aluminum (400°F/204°C)			
Length of Indication (Uninterrupted)	240" (610 cm)			

\*Dimensions vary due to connections, material and specific gravity.

Note: Additional materials, floats, connections and manufacturing techniques are available to extend lengths and operational capabilities. Please contact Gems if the parameters above do not meet your requirements.

### Miniature SureSite Performance



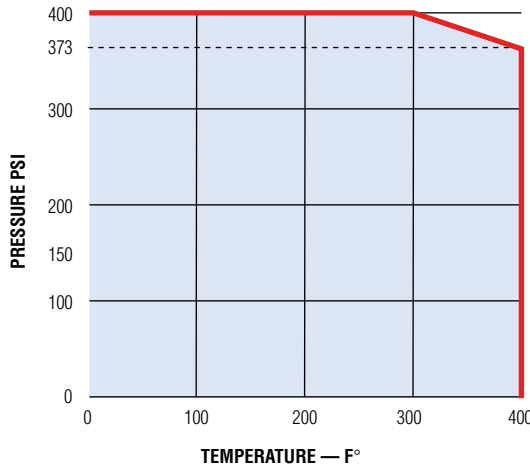









Gems configures Miniature SureSite Indicators, using various materials and fittings, to perform within the Pressure/Temperature parameters specified in the chart at right. Consult the factory with pressure/temperature requirements that fall outside the parameters shown here.











Note: SureSite Indicators are available for temperatures as low as -200°F (-129°C)















**2. Connection Codes**  
(See complete descriptions below)

	Blind		NPT				Flange		Weld	
	Fixed	Removable	Fixed		Removable		Fixed	Removable	Socket Butt	Removable Butt
			Female	Male	Female	Male				
<b>TOP</b>  <b>T</b>	<b>T1</b> 	<b>T10</b> 	<b>T2</b> 	<b>T3</b> 	<b>T11</b> 	<b>T12</b> 	<b>T19</b> 	<b>T20</b> 	<b>T18</b> 	<b>T13</b> 
<b>Sanitary Connections</b>							<b>T7</b> 	<b>T8</b> 		

	Blind	NPT		Flange	Sanitary Flange	Buttweld Nipple
		Male	Female			
<b>SIDE</b>  <b>Sa</b>	<b>S1</b> 	<b>S2</b> 	<b>S3</b> 	<b>S4</b> 	<b>S5</b> 	<b>S6</b> 
<b>SIDE</b>  <b>Sb</b>						

	Blind		NPT				Flange		Weld	
	Fixed	Removable	Fixed		Removable		Fixed	Removable	Socket Butt	Removable Butt
			Female	Male	Female	Male				
<b>BOTTOM</b>  <b>B</b>	<b>B1</b> 	<b>B10</b> 	<b>B2</b> 	<b>B3</b> 	<b>B11</b> 	<b>B12</b> 	<b>B19</b> 	<b>B20</b> 	<b>B18</b> 	<b>B13</b> 
<b>Sanitary Connections</b>							<b>B7</b> 	<b>B8</b> 		

— Connection Codes and Materials background-shaded in this color are stocked by Gems. Select these connections where possible to obtain the most economical SureSite Indicators with a prompt 3-day delivery.

Note: Gems recommends a removable top and/or bottom connection for float access.

**Connection Code Descriptions**

Please provide all connections when completing the Order! Product Check List (located on the following page).

**Note:** Before selecting your connections, consider incorporating your vent and drain requirements.

**T & B (Top and Bottom)**

- T/B 1. Welded cap
- T/B 2. Welded cap with FNPT
- T/B 3. Welded cap with MNPT
- T/B 7. Sanitary flange
- T/B 8. Sanitary flange with mating blind flange
- T/B 10. Standard fixed flange/mating blind flange
- T/B 11. Standard fixed flange/mating FNPT reducing flange
- T/B 12. Standard fixed flange/mating flange with MNPT nipple
- T/B 13. Standard fixed flange/mating flange with butt weld nipple
- T/B 18. Welded cap with butt weld nipple
- T/B 19. Welded cap with ANSI flange
- T/B 20. Standard fixed flange/mating reducing flange spool with ANSI flange

**Sa & Sb (Sides)**

- S1. No connection
- S2. MNPT nipple
- S3. FNPT coupling
- S4. ANSI flange
- S5. Sanitary flange
- S6. Buttweld nipple



Need it quick? Choose materials and components with the color shading for 3-Day manufacturing and shipping. See the Product Configurator section at [www.gemssensors.com](http://www.gemssensors.com) for further details.

**Accessories – Pages D-16 to D-18**

Make more of your SureSite® Indicator with the productivity-enhancing accessories found at the end of this section.

- **Indicating Scales**  
Add graduations to your flag indication.
- **Switch Modules**  
Control pumps, valves, alarms, etc. Mount externally on housing for infinite positioning.
- **Continuous Output Transmitters**  
Signal conditioned for compatibility with most electronic instruments to 300°F (149°C).

**Performance Notes:**

1. As an option **either** the Switch Modules or Transmitter can be used on a Miniature SureSite Indicator - **Not Both**.
2. Minimum specific gravity is 0.7.
3. Standard O-ring seal material is Viton®. Others available upon request.
4. Electropolished Outer Diameter (OD) and/or Inner Diameter (ID) housings available upon request.

Order from: **C A Briggs Company**; 622 Mary Street; Suite 101 - Warminster, PA 18974  
Phone: 267-673-8117 - Fax: 267-673-8118; E-Mail: [Sales@cabriggs.com](mailto:Sales@cabriggs.com) - [www.cabriggs.com](http://www.cabriggs.com)

<p><b>FAX IT!</b></p> <p style="font-size: 24pt;">267-673-8118</p> <p><b>Photocopy This Form</b></p> <p>Use one form for each product type you are selecting.</p> <p><small>This form may also be completed online at <a href="http://gemssensors.com">gemssensors.com</a> for RFQ.</small></p>	<p>This is a <input type="checkbox"/> Request for a Quote      Name _____</p> <p style="padding-left: 40px;"><input type="checkbox"/> Order P.O.# _____      Company _____</p> <p>Quantity Needed _____      Street _____</p> <p>Date Required ____/____/____      City _____ State ____ Zip _____</p> <p>Shipping Method: _____      Phone ( _____ ) _____</p> <p>Partials Accepted: <input type="checkbox"/> Yes      Fax ( _____ ) _____</p> <p style="padding-left: 40px;"><input type="checkbox"/> No</p>
---	--

## SureSite Indicators, Alloy Versions – Miniature Size

### Process Conditions

This information is essential to the accurate and proper operation of your SureSite® Visual Level Indicators. Please complete fully and accurately.

- |   |   |
|---|---|
| <p><b>1. Pressure:</b> Operating _____ psig    Maximum _____ psig</p> <p><b>2. Temperature:</b> Operating _____ °F    Maximum _____ °F</p> <p><b>3. Liquid Media:</b> _____</p> | <p><b>4. Specific Gravity @ Operating Condition:</b> _____</p> <p><b>5. Viscosity:</b> _____ SSU</p> <p><b>6. Application Location:</b> <input type="checkbox"/> Indoors    <input type="checkbox"/> Outdoors</p> |
|---|---|

### Physical Configuration

#### 1. Mounting Configuration Types:

- Type AM     Type BM     Type CM     Type DM

#### 2. Connection Codes – Complete all 4 connection code lines.

Check off NPT or Flange size where appropriate.

▼ Connection Code Number Goes Here. **Connection Code Numbers and their descriptions are on Page D-5.**

Top <b>T</b>	NPT or Weld	Flange	
	<input type="checkbox"/> 1/2" <input type="checkbox"/> 3/4" <input type="checkbox"/> Other _____	<input type="checkbox"/> 1/2" <input type="checkbox"/> 3/4" <input type="checkbox"/> 1" <input type="checkbox"/> Other _____	<input type="checkbox"/> 150# RF <input type="checkbox"/> 300# RF <input type="checkbox"/> Other _____
Side <b>Sa</b>	NPT or Weld	Flange	
	<input type="checkbox"/> 1/2" <input type="checkbox"/> 3/4" <input type="checkbox"/> Other _____	<input type="checkbox"/> 1/2" <input type="checkbox"/> 3/4" <input type="checkbox"/> 1" <input type="checkbox"/> Other _____	<input type="checkbox"/> 150# RF <input type="checkbox"/> 300# RF <input type="checkbox"/> Other _____
Side <b>Sb</b>	NPT or Weld	Flange	
	<input type="checkbox"/> 1/2" <input type="checkbox"/> 3/4" <input type="checkbox"/> Other _____	<input type="checkbox"/> 1/2" <input type="checkbox"/> 3/4" <input type="checkbox"/> 1" <input type="checkbox"/> Other _____	<input type="checkbox"/> 150# RF <input type="checkbox"/> 300# RF <input type="checkbox"/> Other _____
Bottom <b>B</b>	NPT or Weld	Flange	
	<input type="checkbox"/> 1/2" <input type="checkbox"/> 3/4" <input type="checkbox"/> Other _____	<input type="checkbox"/> 1/2" <input type="checkbox"/> 3/4" <input type="checkbox"/> 1" <input type="checkbox"/> Other _____	<input type="checkbox"/> 150# RF <input type="checkbox"/> 300# RF <input type="checkbox"/> Other _____

- 3. Length of Visual Indication – L:** \_\_\_\_\_ inches (240", Max.).  
 Connection to Connection Dimension – C to C: \_\_\_\_\_ inches.

#### 4. Flag Type

- Plastic flags available to 300°F (149°C).  
 Aluminum flags only for temperatures to 750°F (399°C).
- Plastic (Orange and White)     Aluminum (Black and Silver)
- Non-Standard; Specify: \_\_\_\_\_, consult factory.

#### 5. O-Ring Material:

- Viton® (Standard)     Ethylene Propylene  
 Other \_\_\_\_\_

#### Special Instructions (Materials, Connections, etc.)

\_\_\_\_\_

\_\_\_\_\_

### Accessories (Pages D-16 to D-18)

- 1. Switch Modules (Single Point):** \_\_\_\_\_ Quantity
- a.  SPST     SPDT     DPDT 120 VAC     DPDT 24 VDC
- b.  Standard – 300°F     High Temperature
- Explosion Proof
- 2. Indicating Scales:**
- Feet and Inches     Inches     Metric     Blank
- Custom Graduations; specify: \_\_\_\_\_
- 3. Continuous Transmitter:**
- Output:  0-5 VDC     0-12 VDC     4-20 mA
- J-Box:  Standard     Explosion Proof

Please contact C A BRIGGS COMPANY for any configuration or special requirements not covered on this form. **267-673-8117**

Quote \$ \_\_\_\_\_      Date Quoted \_\_\_\_/\_\_\_\_/\_\_\_\_

