

Mechanical - Tilt Float Level Switch

From MDI, Inc.

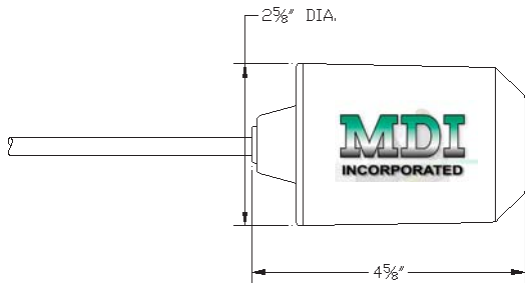



Features

- Oil Resistant Cable
- Epoxy Sealed Cable
- Impact & Corrosion Resistant ABS Shell
- NO, NC, or SPDT Contacts
- Various Cable Lengths
- Color Coded Body

Designed for level control and alarm applications in difficult liquids such as sewage and waste water. Mechanical tilt floats are ideal for applications where the presence of mercury is a concern. They have impact resistant ABS shell and neoprene jacketed cable.

Mechanical - Tilt Float Level Switches

Model Number ¹	Angle	Switch	Cable Length	Cable Specification	Contact Rating	Temperature Rating	Listings
PB20W2000	25° Narrow	SPST - NO	20'	16 gauge 2-wire (SPST) 3-wire (SPDT) SJOW Oil Resistant CPE	13 amp @ 120/ 240VAC 1/2 HP 58.8 AMP overload	140° F 60° C	 File #E-93774
PB20W4000	25° Narrow	SPST - NO	40'				
PY2CW2000	25° Narrow	SPST - NC	20'				
PY2CW4000	25° Narrow	SPST - NC	40'				
GF20W2000	90° Wide	SPST - NO	20'				
GF20W4000	90° Wide	SPST - NO	40'				
GW2CW2000	90° Wide	SPST - NC	20'				
GW2CW4000	90° Wide	SPST - NC	40'				
GG2DW2000	90° Wide	SPDT	20'				
GG2DW4000	90° Wide	SPDT	40'				
SPF5609-40	60° Wide	SPST - NO	40'	Hi-Temp Float w/Teflon Cable & Attached Weight	10A @120/240VAC 1/4 HP	225° F - 107° C	 File #LR41198
KG2DW4000	25° Narrow	SPDT	40'	Tetherless with Internal Weight & Standard Cable		140° F - 60° C	

Part Number for Tethers: See Other side of Page



¹To include Tether with Float Add Suffix: T for Tie, TC for Stainless Tether Clamp, W for Cast Weight or P for PVC Weight to Float Part Number.

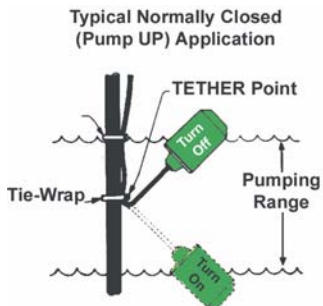

G Series
90° Wide
Angle
Float

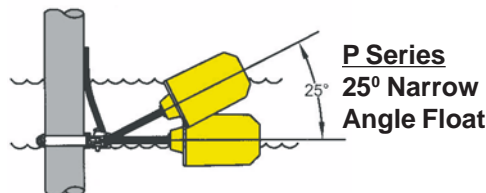

Warrick Series 67 Duplex Pump Controller

- Make Floats UL Intrinsically-Safe.
- Duplex Pump Control with Hi and Low Alarm.
- Automatic or Manual Alternation.
- Built-in Silence / Acknowledge.
- SPDT Alarm Output with LED Indication.
- 4 SPDT Relays or Isolated Form A & B per Channel.
- Consider model 67C1C0A or 67C1A0A Respectively.
- See Page D-17 of Gems Catalog 2004.

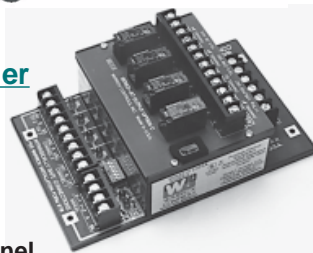

Warrick Series 17 Controller

- Make Floats FM Intrinsically-Safe.
- Single Channel Alarm or Differential Pump Control.
- Selectable Sensitivity.
- Isolated Form A & B Output.
- Consider model 17A1X0.
- see Page D-15 of Gems Catalog 2004.



Applications

- Level Control
- Alarms
- Sewage Lift Systems
- Slurries
- Drainage Sumps
- Wastewater Treatment
- Holding Tanks

C. A. BRIGGS COMPANY
632 Davisville Road; Willow Grove, PA 19090
THE LEVELWORKS® PEOPLE

Your ORDERING LINES

Phones:
215-784-9250
717-428-3492
410-366-1554
800-352-6265

FAX:
215-784-0611
On-Line Store:
www.TheLevelWorksStore.com

E-Mail
sales@cabriggs.com

Mercury - Tilt Float Level Switch From MDI, Inc.

Features

- Oil Resistant Cable
- Stainless Steel Mercury Capsule
- Epoxy Sealed Cable
- High Impact & Corrosion Resistant Polystyrene Shell
- NO or NC Contacts
- Various Cable Lengths
- Color Coded Body

Designed for level and alarm control applications in difficult liquids such as sewage and slurries, Mercury float switches consist of an oil-resistant cable soldered to a stainless steel mercury capsule, housed in a High Impact Polystyrene (HIPS) shell.

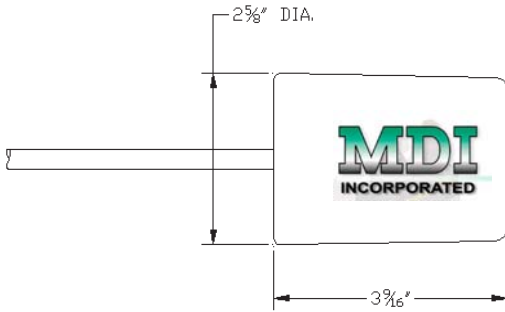

Mercury - Tilt Float Level Switches

Model Number ¹	Angle	Switch	Cable Length	Cable Specification	Contact Rating ²	Temperature Rating	Listings
CM10W2000	25° Narrow	SPST - NO	20'	16 gauge 2-wire (SPST) SJOW Oil resistant CPE	13 amp @ 120VAC / 6 amp @ 240VAC	140° F 60° C	 File #E-93774 File #LR41198
CM10W4000	25° Narrow	SPST - NO	40'				
CB1CW2000	25° Narrow	SPST - NC	20'	16 gauge 2-wire (SPST) SJOW Oil resistant CPE	13 amp @ 120VAC / 6 amp @ 240VAC	140° F 60° C	 File #E-93774 File #LR41198
CB1CW4000	25° Narrow	SPST - NC	40'				

Part Number for Tethers:

- Float Tie Model# is: **Float-Tie**
- Stainless Steel Tether Clamp is: **TC-2**
- Cast Weight Model# is: **Float-Weight** Zinc Plated Cast Iron
- PVC Weight Model# is: **1002230** All PVC

¹To include Tether with Float Add Suffix: T for Tie, TC for Stainless Tether Clamp, W for Cast Weight or P for PVC Weight to Float Part Number.

²Floats available with 1A Contact.

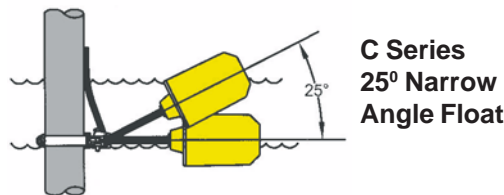
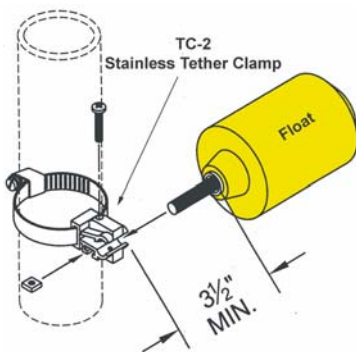

C Series
25° Narrow
Angle Float

Applications

- Level Control
- Alarms
- Sewage Lift Systems
- Slurries
- Drainage Sumps
- Wastewater Treatment
- Holding Tanks

Warrick Series 67 Duplex Pump Controller

- Makes Floats UL Intrinsically-Safe.
- Duplex Pump Control with Hi and Low Alarm.
- Automatic or Manual Alternation.
- Built-in Silence / Acknowledge.
- SPDT Alarm Output with LED Indication.
- 4 SPDT Relays or Isolated Form A & B per Channel.
- Consider model 67C1C0A or 67C1A0A Respectively.
- See Page D-17 of Gems Catalog 2004.

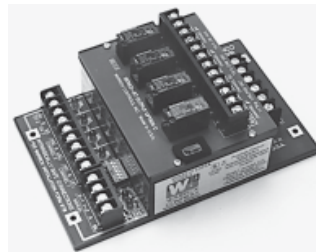

Warrick Series 17 Controller

- Make Floats FM Intrinsically-Safe.
- Single Channel Alarm or Differential Pump Control.
- Selectable Sensitivity.
- Isolated Form A & B Output.
- Consider model 17A1X0.
- see Page D-15 of Gems Catalog 2004.



Your ORDERING LINES

C. A. BRIGGS COMPANY
632 Davisville Road; Willow Grove, PA 19090
THE LEVELWORKS® PEOPLE

Phones:
215-784-9250
717-428-3492
410-366-1554
800-352-6265

FAX:
215-784-0611
On-Line Store:
www.TheLevelWorksStore.com

E-Mail
sales@cabriggs.com